

Powerful, yet compact.

HOMAG

Our panel dividing saws
SAWTEQ B-180

YOUR SOLUTION





SAWTEQ B-180 – an efficient saw at a low price

Special requirements demand special solutions. That is why HOMAG has developed a panel dividing saw especially for Asia, the SAWTEQ B-180. This saw offers an optimum price/performance ratio, boasts impressive precision and can be flexibly tailored to your requirements.

YOUR SOLUTION

CONTENTS

- 04 Software
- 10 SAWTEQ B-180
- 12 SAWTEQ B-180 with lifting table
- 14 Standard features
- 20 Optional features
- 25 Technical data
- 26 Service

What's different? The software!

It efficiently integrates the machine into the production process. This results in seamless, intelligently networked processes from start to finish. In short: the right software unlocks new value-added potential. That is what makes it so important.



CADmatic saw control system – time-tested and pioneering

The SAWTEQ B-180 is controlled by our proven CADmatic software. All saw models are equipped as standard with CADmatic 5 – the latest generation of the HOMAG saw control system.

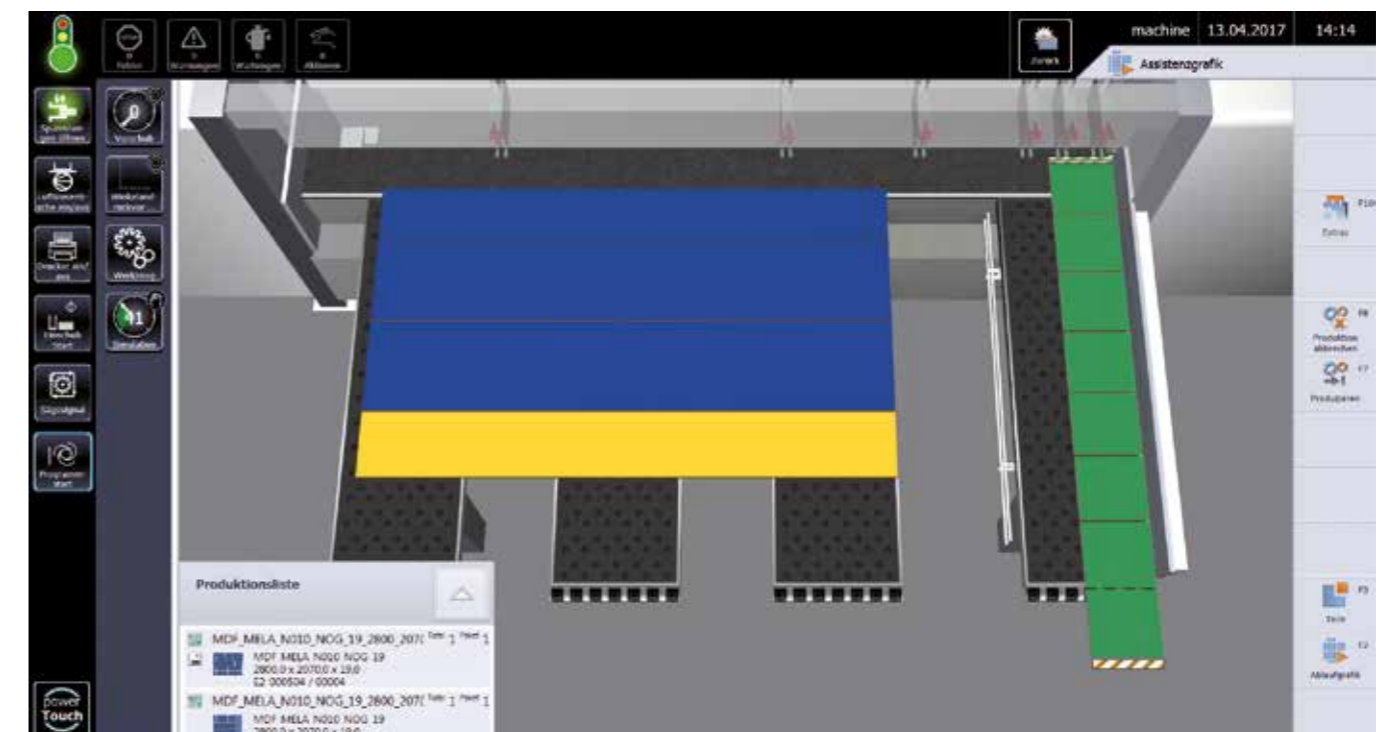

CADmatic 5

The latest generation of the HOMAG saw control system is open for data exchange and digital networking with other machines and software solutions. CADmatic 5 also includes a new assistance graphic that clearly shows the machine operator what he has to do next. Compared to the previous process graphic that showed all the work steps of the saw (and can still be called up if required), this new graphic represents a 180-degree change in perspective!

Highlights:

- The new 3D assistance graphic supports the operator and is intuitive to operate, which shortens the training period and reduces errors to a minimum
- This results in efficient processes and a steady output
- Simple handling via tapping and swiping (touch functions)
- Quick change between the individual sections
- Graphically supported diagnostics
- powerTouch user interface
- Ready for connection to tapio
- 21" full-HD widescreen monitor with multi-touch display

Find out more in the "CADmatic" brochure.

Optional features: increasing productivity with the appropriate cutting optimization software

Production time, material yield, parts handling and logistical process: efficient panel cutting with seamless processes requires intelligently optimized cutting patterns. For HOMAG saws, you can get the appropriate optimization solution on demand – from large to small, as permanently installed software or directly from the tapio cloud. You have the choice because the SAWTEQ B-180 with lifting table is now tapio-ready.



intelliDivide – the easy way to first-class optimization results

Simply upload the parts list. Done! The result? A choice of several alternatives for cutting patterns and entire runs. That's how easy intelliDivide makes it.

In detail: the cloud-based optimization software intelliDivide utilizes significantly higher computing capacities than are available for locally installed optimization software and can therefore swiftly provide the user with several alternative optimization results.

This means that with intelliDivide, the operator can choose from a variety of options, including a result based purely on reducing waste, a result based on the shortest machine running time or on the simplest handling, perfectly adapted to the relevant requirements.

Applications are varied and are geared towards both the trade and industry. Would you, for example, occasionally like to optimize cutting patterns without having to buy, install and maintain a software solution? Then intelliDivide is just what you need. This is because you can use intelliDivide on demand, as “software as a service”.

However, intelliDivide is also very interesting for large companies. Why is that so? Because, via the cloud, you can optimize your cutting patterns extremely quickly, intelligently and accurately with the help of a powerful calculation engine.

The SAWTEQ B-180 with lifting table is tapio-ready, which means that intelliDivide recognizes the machine configuration of your saw automatically and can take it into account for every optimization in the cloud. This pays off every time in the case of high material throughput.



Cut Rite cutting optimization software

Efficiency through planning: this short phrase sums up the key benefits of the Cut Rite software. With this world-leading software solution, you can optimize waste and systematically lower the overall costs for cutting.

- Optimized project control
- Efficient cutting processes
- Full control of costs
- Faster calculations

Find out more in the “Cut Rite” brochure.

CADplan

As an alternative to the comprehensive Cut Rite optimization software, CADplan, an add-on module for CADmatic, can also be used to perform small optimization jobs directly at the saw.

SAWTEQ B-180

Whoever wants to have the edge over their competitors needs a panel dividing saw of unrivaled efficiency, offering reliability and high throughput at a competitive price. The SAWTEQ B-180 boasts precisely these strengths.

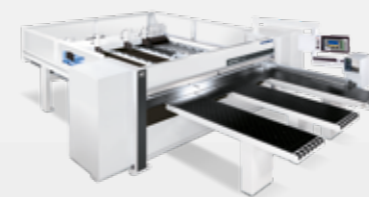

The highlights

- Power Concept PRACTIVE (optional)
- Improved safety equipment
- Scoring saw adjustment now motor driven



SAWTEQ B-180 with lifting table

With an integrated lifting table, you can deal with your cutting processes more ergonomically, faster and more efficiently. In addition to solely manual feeding from the front, program-controlled feeding from the rear is also possible – automatically during the saw cycle.



The highlights

- Automatic feeding via integrated lifting table
- Saw carriage feed rate up to 120 mm/min available as an option
- Optional 15 kW main saw motor instead of the standard 13.5
- Available with Power Concept PRACTICE

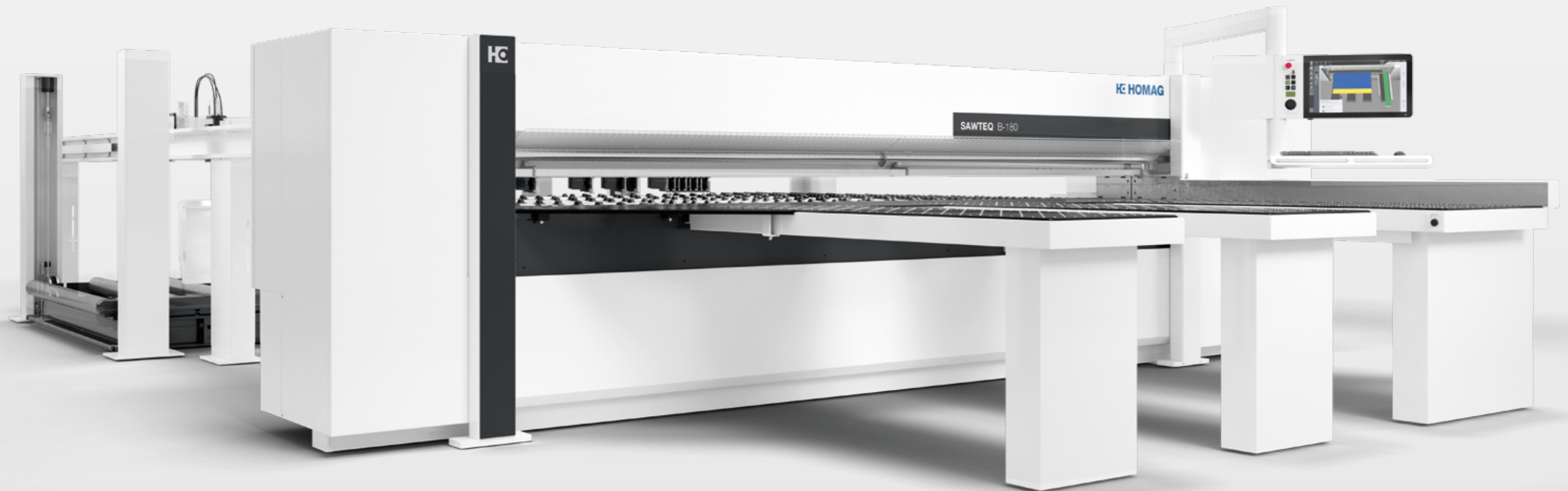



Standard features

The SAWTEQ B-180 stands for outstanding engineering quality. You get top-class performance at a low price – even in the basic configuration.

Standard features: everything has been thought of

Low maintenance, ergonomic, material-friendly, powerful and optimized processes: these are but a few of the good qualities that the SAWTEQ B-180 owes to its remarkable set of standard technical features.



Saw carriage with Power-Loc

Exceptionally quiet operation, high precision and low energy consumption are the hallmarks of the new saw carriage.

- Torsion-resistant, rugged and resilient basic design of the steel plate body for maximum dynamics and precision
- New: motor-controlled scoring saw adjustment
- Infinitely variable feed speed – for precision cutting of demanding materials
- Long-term accuracy of saw blade projection
- Low-noise, maintenance-free drive unit
- Light sensor cleaned by brush
- Power-Loc system: quick and easy saw blade change



HOMAG patent: central side pressure device

- Integrated directly in the saw carriage. This reduces cycle times by up to 25% in comparison with conventional systems
- The contact pressure is infinitely variable – ideal for thin panels, laminates or sensitive materials



Clamps

- Robust
- Gentle positioning of material
- The short, rugged design allows material to be precisely held and guided more gently
- Irrespective of the book height, the top fingers of the clamps do not exert any leverage; instead, they are lowered horizontally and their entire contact surface rests on the material. This increases the working depth and ensures material is held firmly
- Designed for continuous, multi-shift operation

Rugged pressure beam

- Large-area pressure zone directly at the cutting line reduces material vibrations to a minimum
- Rack and pinion ensure the necessary parallel adjustment
- This results in accurate, clean cuts, for books too

Program fence

- Precision and dimensional accuracy
- Resistant to torsion and bending
- Electronically controlled
- Precision guidance
- Electromagnetic measuring system guarantees a positioning accuracy of +/- 0.2 mm per meter
- Measuring system involves no wear and no maintenance

Additional standard features for saws with lifting table

The SAWTEQ B-180 with integrated lifting table is equipped with more technology from the start for technical reasons.

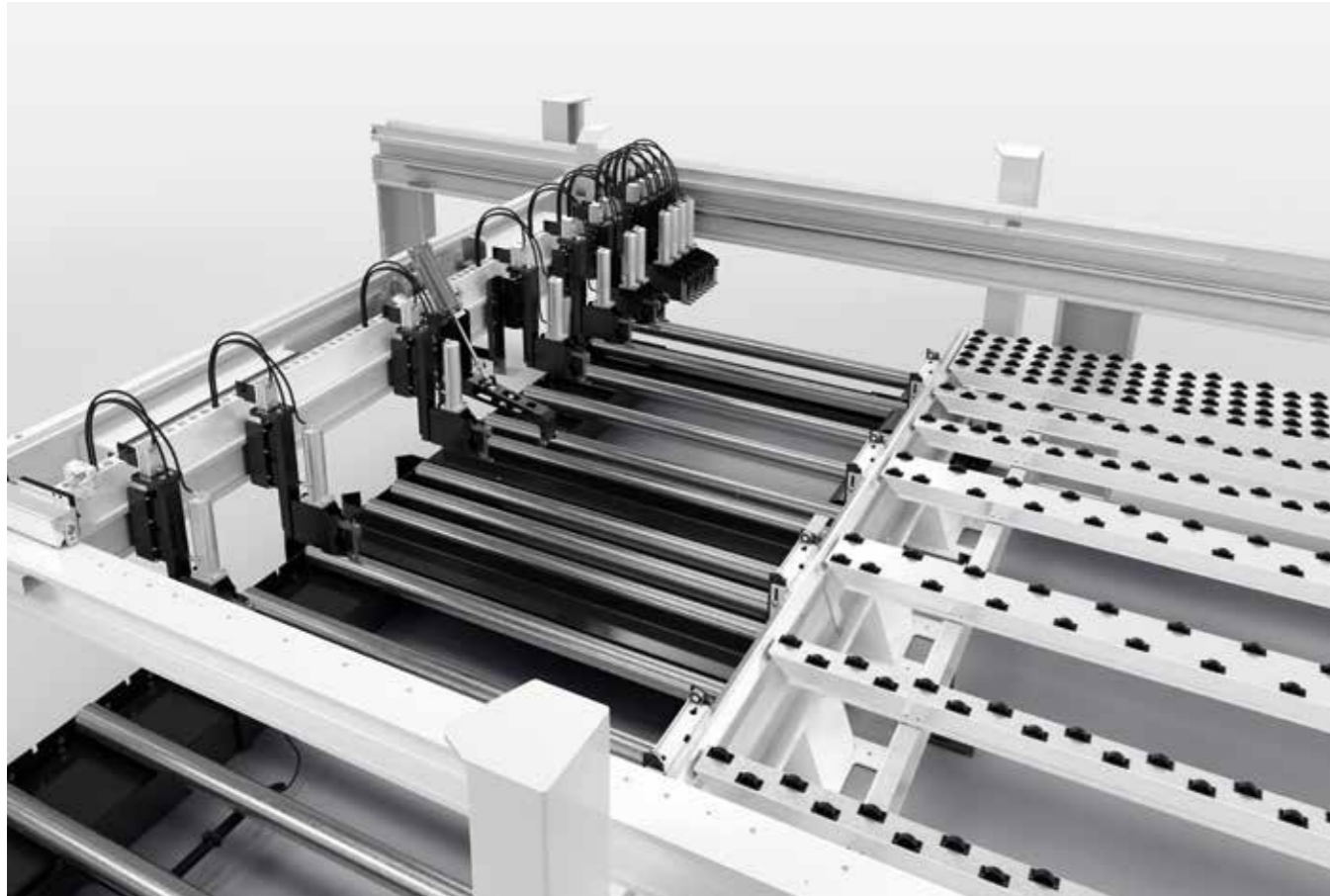

Powerful feeding system

- Panels are fed via an electro-hydraulic four-column lifting table
- Automatic determination of book height
- Equipped with driven rollers as standard
- Sensing device for precise panel handling
- Also suitable for thin materials from 9.5 mm upwards
- Maintenance-free and no lubrication required



Separate backing wall

The backing wall is not attached to the machine bed, ensuring precise cuts. This is because vibrations caused by the movement of stacks on the lifting table are not transferred to the machine bed.

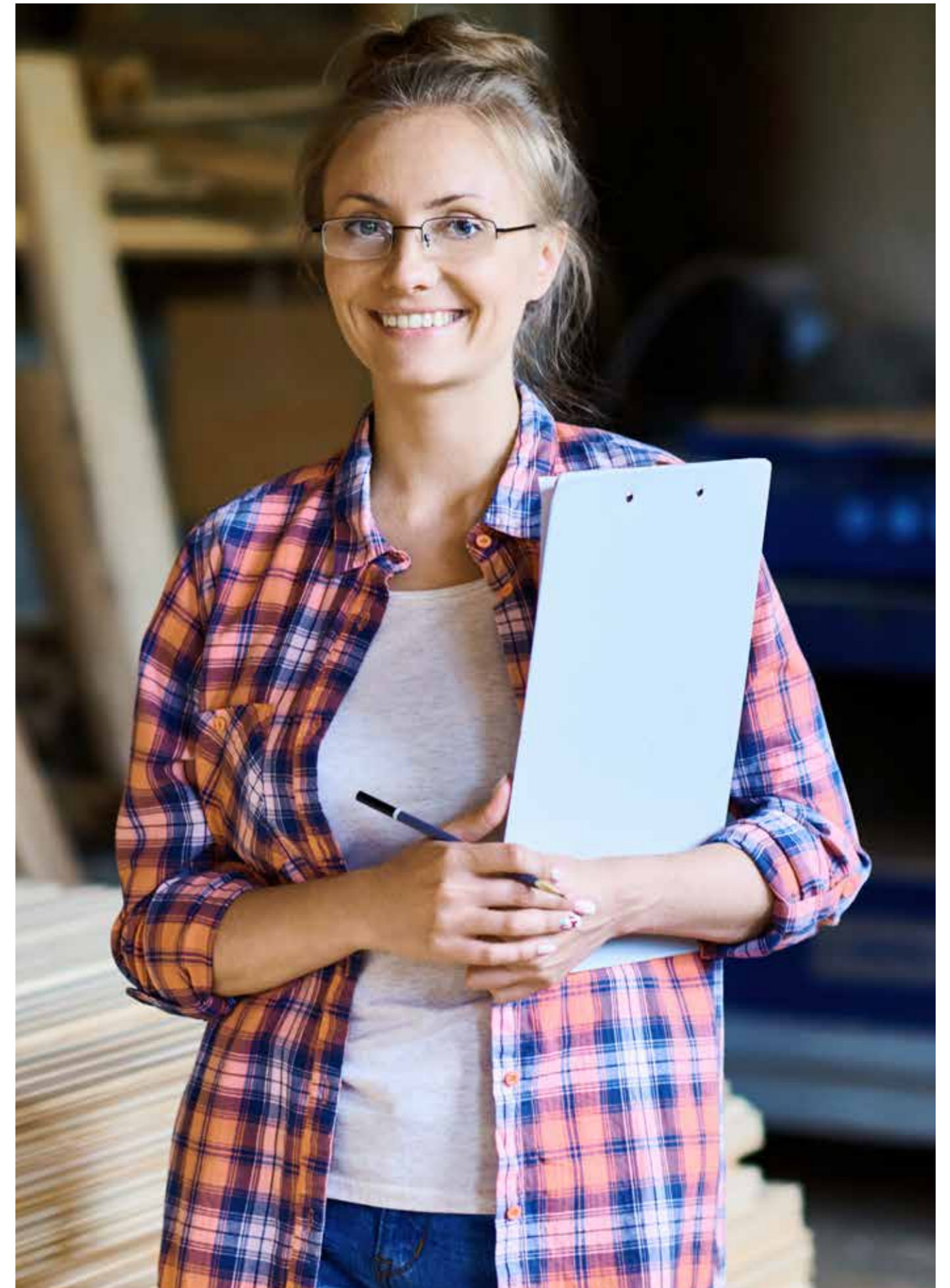



Optional features

More is always possible at HOMAG: higher output, better ergonomics, improved cutting processes. We offer you the choice of many optional technologies for increasing efficiency in panel cutting.

Extras for improved efficiency and ergonomics

Get more out of your SAWTEQ B-180 with the following extras. In panel handling or by highly efficient labeling of finished parts at the saw.



Machine table equipped with air jets throughout

Anyone working with sensitive material or especially heavy panels and books will benefit from the machine table being equipped with air jets throughout.

More extras

Opt for additional clamps, with 1 or 2 fingers.



New option for additional safety

For maximum operating safety, the SAWTEQ B-180 can now be equipped with an optional protective guard. This screens off the entire rear machine table, thus preventing inadvertent access. A great gain in safety for a small investment.



Greater efficiency, fewer errors: label printer

To create custom labels directly at the saw and design them as required with a barcode, text or even graphics. If you also use our Cut Rite optimization software, the material goes directly to the next process step with printed instructions.

You would like to buy your printer yourself? We can provide the platform for you.

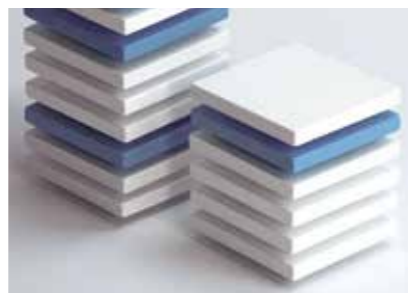

Performance package – for saws with lifting table

Comprises a saw carriage speed of 120 m/min instead of 80 m/min, pressure beam height control for faster positioning and a 15 kW main saw motor.

Tailored storage system integration

HOMAG offers you a wide range of feeding solutions, large and small, for your saw.



Simple storage system integration with CADmatic support

Ideal for all SAWTEQ B-180 saws and feeding from a storage system separated from the saw. How it works:

- On the basis of cutting patterns optimized in the office, the horizontal storage system assembles a stack of panels for cutting
- Using the CADmatic function "JoblistControl", you document the result in a material list
- Now you move the finished stack of panels to the saw with, for example, a fork-lift truck
- At the saw, you simply scan the bar code on the material list prepared by "JoblistControl"
- Now the saw knows what has to be done and starts the cutting process

Storage system integration via roller conveyors to the air cushion table (see ill.)

You can connect your SAWTEQ B-180 to a panel store via roller conveyors to the air cushion table. How it works:

- The storage system is connected via a roller conveyor at the side of the air cushion table on the left
- This roller conveyor transports the panels or books of panels to the air cushion tables
- The corresponding optimized cutting pattern is selected via the CADmatic control software
- Once the panel or book of panels is on the air cushion tables, the respective production run can start
- Perfect handling – even with just one machine operator
- Easy, ergonomic operation

Storage system integration – only for saws with lifting table

Enables stacks to be fed directly from the store. How it works:

- The horizontal storage system creates a stack that is then transported via roller conveyor directly to the lifting table
- Roller conveyor connection from the right or the left
- Once the lifting table has been loaded, the production data is automatically transferred to the saw

Power Concept PRACTICE

The innovative Power Concept PRACTICE boosts performance and throughput still further



Power Concept PRACTICE with:

- An additional clamp that operates independently
- Clamps on the program fence that can be raised out of the overlapping work area as needed
- Re-sorting the strips directly at the saw so that they are ideally matched to Power Concept PRACTICE. This is based on existing optimization data for the shortest machining times

Please note:

- Protective fence instead of protective guard
- Cannot be combined with Easy2Feed
- When Power Concept PRACTICE is used, saw blade projection is automatically limited to a maximum of 80 mm for technical reasons

POWER CONCEPT

Up to **40%** more output



Lower costs per cut



Significantly improved material flow



High material throughput

TECHNICAL DATA*

Model	SAWTEQ B-180	SAWTEQ B-180 with lifting table
Saw blade projection (mm)	95	95
Cutting length (mm)	3,800	3,800
Clamps	6 (option of up to 5 more)	6 (option of up to 5 more)
Saw carriage speed (m/min)	up to 120	up to 120
Program fence speed (m/min)	70**	70**
Operating software	CADmatic 5	CADmatic 5
Operating system	Windows 7	Windows 7
Monitor	21" TFT flat screen monitor	21" TFT flat screen monitor
Main saw motor (kW)	13.5	13.5 (optional: 15)
Scoring saw motor (kW)	2.2	2.2
Main saw blade (mm)	380 x 4.4 x 60	380 x 4.4 x 60
Scoring saw blade (mm)	200 x 4.4 - 5.4 x 45	200 x 4.4 - 5.4 x 45
Average total air requirement (NI/min)	150	150
Extraction system (m³/h)	3,350 (26 m/sec)	3,350 (26 m/sec)

* Values relate to the standard version

** Forwards 25 m/min

*** Dim. A: incl. 64 mm for extraction connection, dim. C: standard program fence width

MACHINE DIMENSIONS***

SAWTEQ B-180	A (mm)	B (mm)	C (mm)
B-180/38/38	6077	7803	4487

MACHINE DIMENSIONS***

SAWTEQ B-180 with lifting table	A (mm)	B (mm)	C (mm)
B-180/38/22	5,867	10,886	4,196

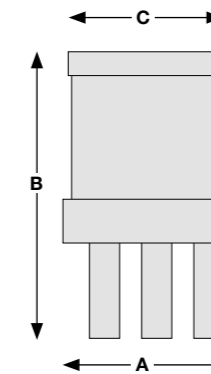



HOMAG LifeCycleService

Optimal service and individual consultations are included in the purchase of our machines. We provide support through service innovations and products that are tailored exactly to your company's requirements. With short response times and

fast customer solutions, we can guarantee excellent availability and cost-effective production for the entire life cycle of your machine.

1,200
service employees worldwide

> 90%
fewer on-site visits due to successful remote diagnostics

5,000
customer training sessions per year

> 150,000
machines electronically documented
in 28 languages in eParts



HOMAG Finance – tailor-made financial solutions

- We offer you tailored financing proposals for your machinery or plants. Our financial advice goes hand in hand with our expertise relating to technical questions. Your personal contact person will take care of the whole process
- The benefits for you: you can invest in new technologies without delay, while remaining financially flexible



Remote service

- Hotline support for the control system, mechanics, and process technology from our remote service specialists. This results in around 90% fewer on-site service visits!
- Mobile applications such as ServiceBoard reduce costs by providing fast assistance in the event of malfunctions via mobile live video diagnostics, online service messages and eParts, the online spare parts shop



Spare part service

- Identify, request and order spare parts 24/7 via www.eParts.de
- Parts available locally worldwide through sales and service companies, as well as sales and service partners
- Reduction in downtimes due to specific replacement part and wear part kits



Modernization

- Keep your machine pool up to date and increase both the productivity and product quality. Meet future product requirements today!
- We provide support through upgrades, modernizations, and individual consultations and development



Training

- Thanks to training that is precisely tailored to your needs, your machine operators can operate and maintain HOMAG machines as efficiently as possible
- You will also receive customer-specific training material with tried-and-tested exercises

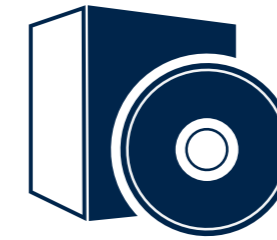

Software

- Telephone support and advice from Software Support
- Digitization of your sample parts using 3D scanning saves time and money in comparison with reprogramming
- Retrospective networking of your machine fleet with intelligent software solutions from design through to production



Field service

- Increased machine availability and product quality thanks to certified service personnel
- Regular checks through maintenance / inspection ensure that your products are of the highest quality
- Minimized downtimes in the event of unforeseeable malfunctions due to the high availability of our technicians

HOMAG Group AG

info@homag.com
www.homag.com



YOUR SOLUTION